

工事フロー図

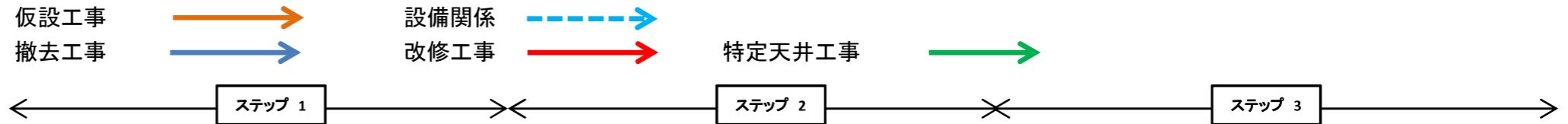

月数		1	2	3	4	5	6	7	8	9	10	11	12	13	14	15	16	17	18	19	20	21	22
設備関係	撤去・切り回し	科学館・落水庭		アトリウム		プール																	
アトリウム				アトリウム床撤去		1FL防水改修		壁解体		外壁新設		準備		屋根解体		準備 床仕上工事		クリーニング					
科学館	科学館・落水庭	準備・仮囲		撤去		杭撤去		外壁新設		工事期間中作業ヤードとして使用													
開発館	プール			準備・仮囲		耐震壁新設		撤去		内装改修・外壁新設													
	受付	現受付使用		▲引越		仮受付使用		▲引越		現受付使用		▲引越		新受付使用		▲引越							
	B1F アスレチックルーム・フィットネスルーム			天井改修		▲引越																	
	B1F レクリエーションジム			天井改修		▲引越																	
	3F 旧キッチンルーム・リラクゼーションルーム			▲引越		解体		内装改修		▲引越													
情報館	1F 旧情報ライブラリー	花壇・外壁撤去		▲引越		出入口新設・内装改修																	
宿泊館	1F プラザホール	▲引越		▲引越										天井改修		▲引越							
騒音・振動・粉塵の影響が大きい期間																							

- *現時点で想定される工事について整理したものであり、今後、さらに工事内容等を検討していく中で変更の可能性あり
- *天井改修工事及び開発館3Fキッチンルーム・リラクゼーションルーム改修工事の実施時期については調整可能
- *プールの設備切り回し工事は1~7の期間で調整可能
- *インフラ切替え工事によるインフラ停止期間は月数 1~4の期間 とそれ以降の工事期間においてそれぞれおよそ、電気:1日×2回、上水:3日×2回、ガス:3日×2回程度 停止期間については現時点での暫定的な算定であり、今後変更の可能性あり

工事ステップ 1

凡例

- 工事エリア
- 使用可能エリア
- 使用可能昇降設備
- 使用可能便所
- 利用者動線
- - - 施設職員・関係者動線
- 工事動線
- - - 一時的な工事動線 (日時限定)
- SS スチールシャッター

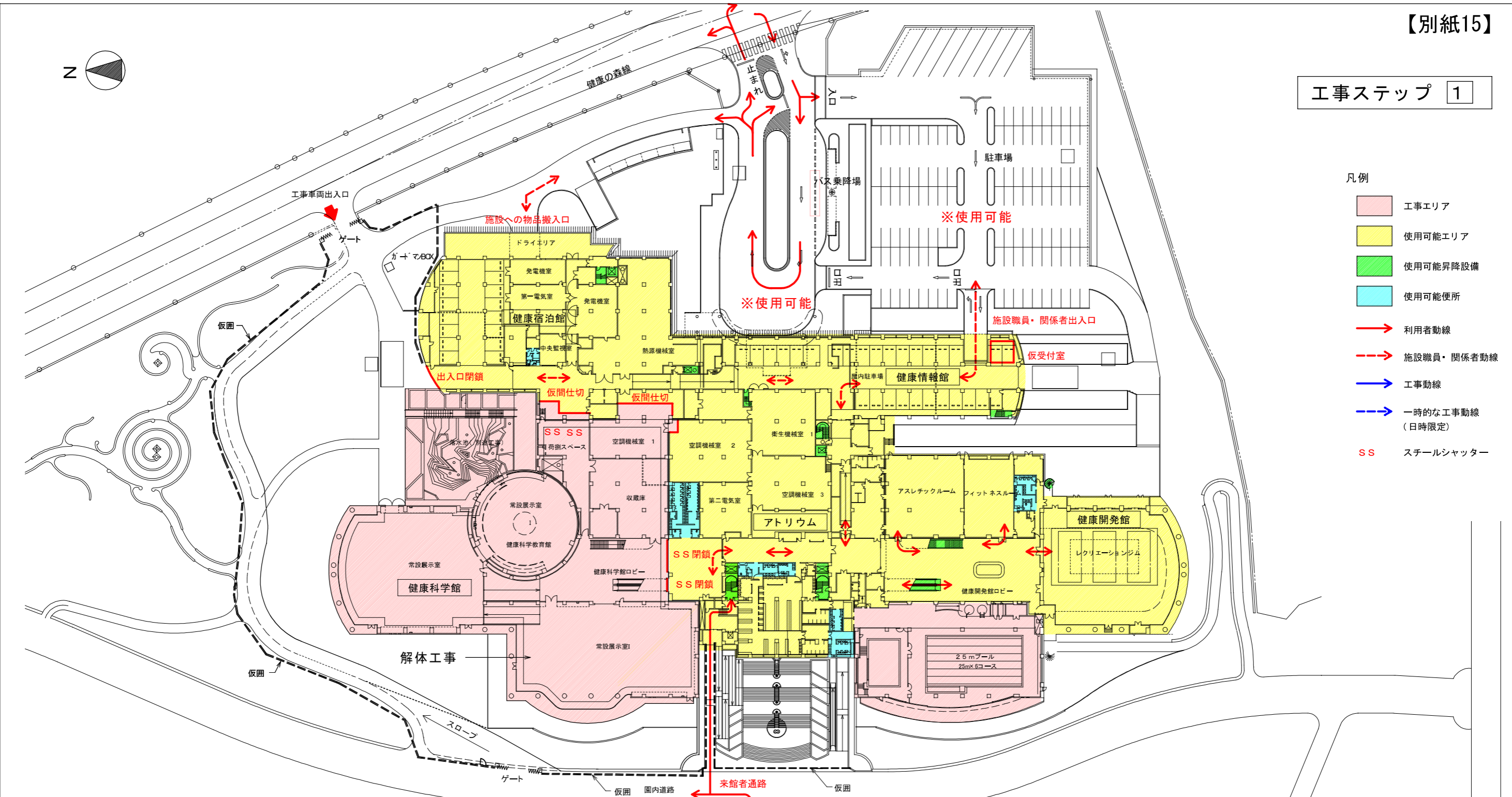

工事フロー

設備関係	1																						2										3																																																											
	1	2	3	4	5	6	7	8	9	10	11	12	13	14	15	16	17	18	19	20	21	22	1	2	3	4	5	6	7	8	9	10	11	12	13	14	15	16	17	18	19	20	21	22																																																
設備関係	撤去・切り回し																						科学館										アトリウム										プール																																																	
アトリウム																							アトリウム床撤去										防水改修										壁解体										外壁新設										屋根解体										仕上工事										クレーン									
科学館	科学館・落水庭																						準備仮囲										撤去										杭撤去										外壁新設										内装改修																													
開発館	プール																						準備										耐震壁										撤去										外壁新設																																							
B1F アスレチックルーム・フィットネスルーム																							天井改修																																																																					
B1F レクリエーションジム																							天井改修																																																																					
3F 旧クッキングルーム 3F 旧リラクゼーションルーム																							出入口・内装改修																				解体										内装改修																																							
情報館	1F 旧情報ライブラリー																						撤去										新設																																																											
宿泊館	1F ブラザホール																						花壇・外壁																				天井改修																																																	

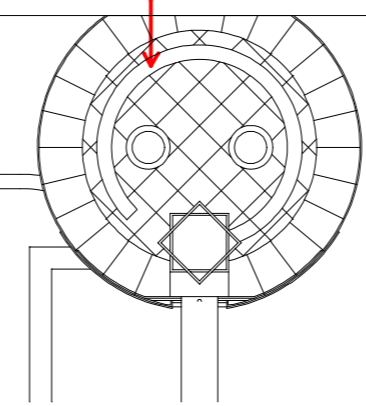

工事ステップ 1

凡例

- 工事エリア
- 使用可能エリア
- 使用可能昇降設備
- 使用可能便所
- 利用者動線
- 施設職員・関係者動線
- 工事動線
- 一時的な工事動線 (日時限定)
- SS スチールシャッター

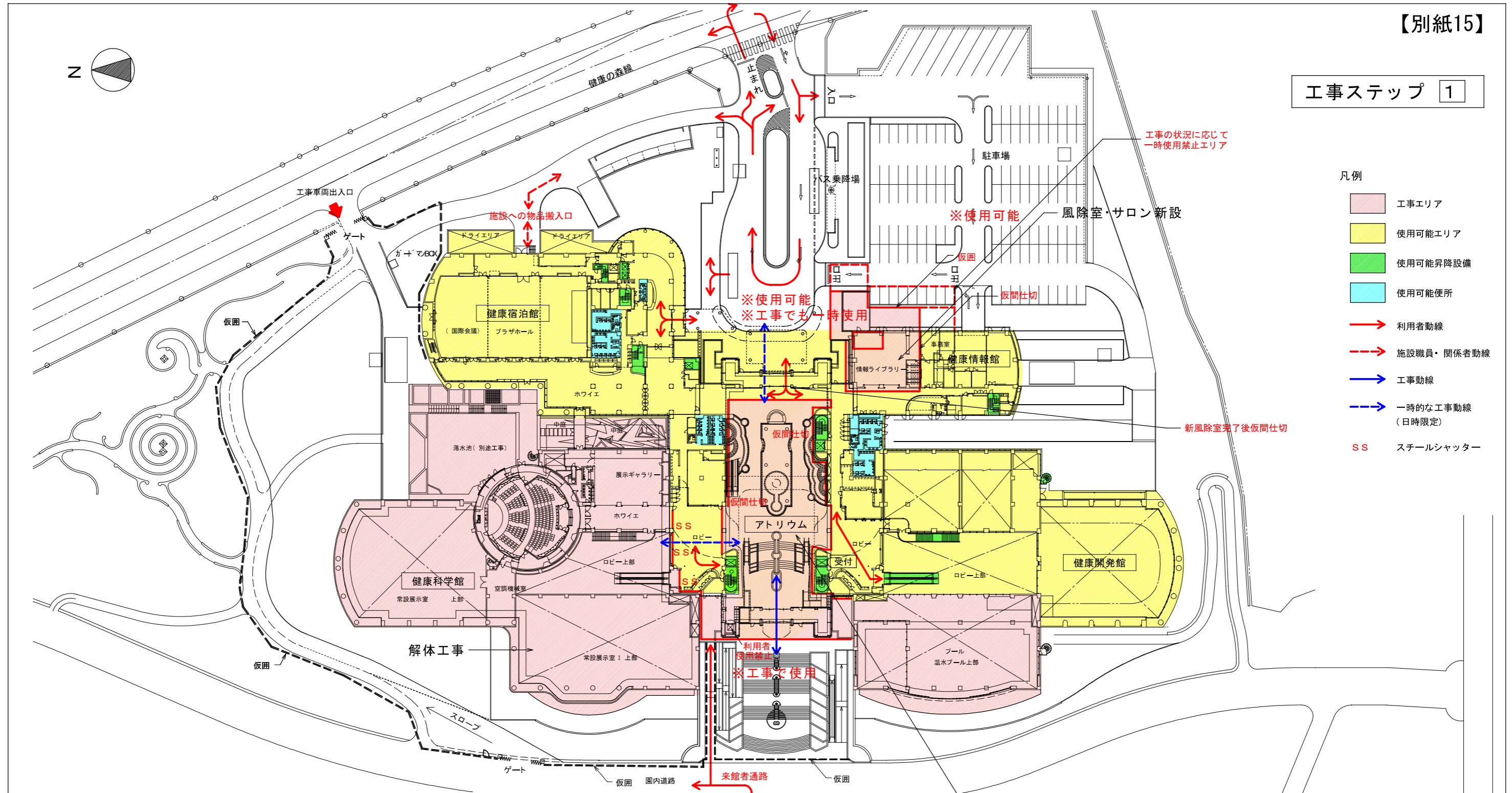

工事フロー

設備関係	1																						2																						3																																																																																																																																			
	1	2	3	4	5	6	7	8	9	10	11	12	13	14	15	16	17	18	19	20	21	22	1	2	3	4	5	6	7	8	9	10	11	12	13	14	15	16	17	18	19	20	21	22	1	2	3	4	5	6	7	8	9	10	11	12	13	14	15	16	17	18	19	20	21	22																																																																																																														
設備関係	撤去・切り回し																						科学館																						アトリウム																						プール																																																																																																													
アトリウム																							アトリウム床撤去																						防水改修																						壁解体																						外壁新設																						屋根解体																						仕上工事																						クレーン																					
科学館	科学館・落水庭																						準備仮囲																						撤去																						杭撤去																						外壁新設																																												内装改修																																											
開発館	プール																																												準備																						耐震壁																						撤去																						外壁新設																																																																	
	B1F 7スチルルーム・フィットネスルーム																																												天井改修																																																																																																																																			
	B1F レクリエーションジム																																												天井改修																																																																																																																																			
	3F 旧クッキングルーム																																																																																																																																				解体																						内装改修																					
	3F 旧リラクゼーションルーム																																												出入口・内装改修																																																																																																																																			
情報館	1F 旧情報ライブラリー																						撤去																						新設																																																																																																																																			
宿泊館	1F プラザホール																						花壇・外壁																																																																																																																																				天井改修																					

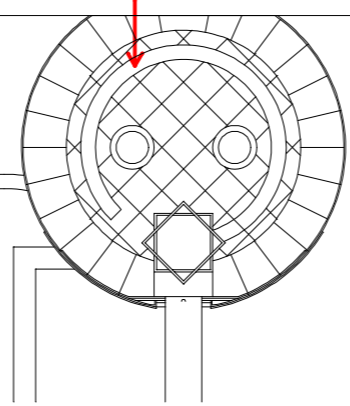

アトリウム床撤去工事

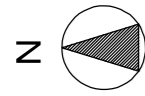

工事ステップ 1

凡例

- 工事エリア
- 使用可能エリア
- 使用可能昇降設備
- 使用可能便所
- 利用者動線
- 施設職員・関係者動線
- 工事動線
- 一時的な工事動線
(日時限定)

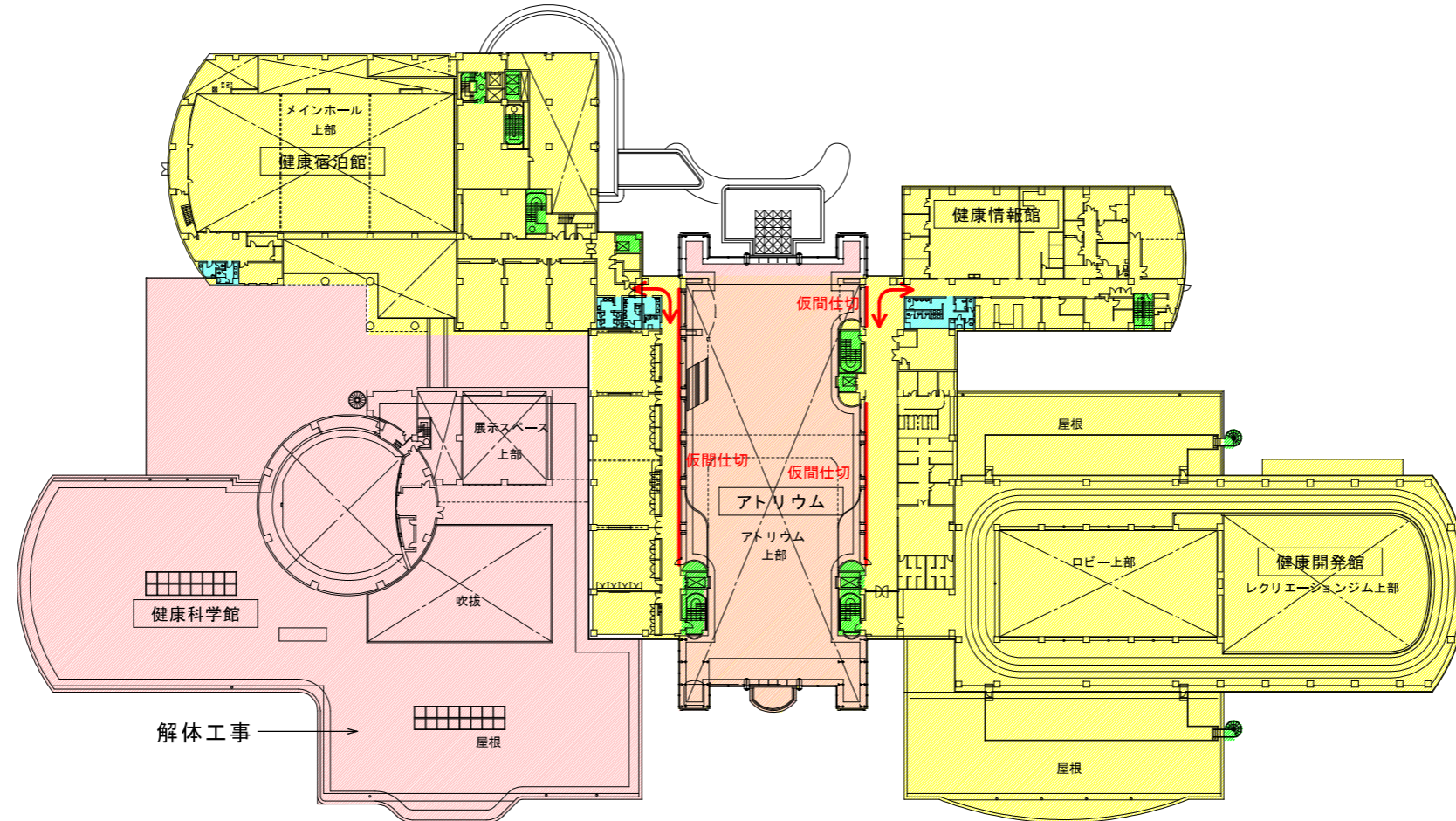

工事フロー

設備関係	1																						2																						3																																																																																																																																			
	1	2	3	4	5	6	7	8	9	10	11	12	13	14	15	16	17	18	19	20	21	22	1	2	3	4	5	6	7	8	9	10	11	12	13	14	15	16	17	18	19	20	21	22	1	2	3	4	5	6	7	8	9	10	11	12	13	14	15	16	17	18	19	20	21	22																																																																																																														
設備関係	撤去・切り回し																						科学館																						アトリウム																						プール																																																																																																													
アトリウム																							アトリウム床撤去																						防水改修																						壁解体																						外壁新設																						屋根解体																						仕上工事																						クレンジング																					
科学館	科学館・落水庭																						準備仮囲																						撤去																						杭撤去																						外壁新設																																												内装改修																																											
開発館	プール																																												準備																						耐震壁																						撤去																						外壁新設																																																																	
	B1F アスチルルーム・フィットネスルーム																																												天井改修																																																																																																																																			
	B1F レクリエーションジム																																												天井改修																																																																																																																																			
	3F 旧クッキングルーム 旧リラクゼーションルーム																																												出入口・内装改修																																												解体																						内装改修																																																																	
情報館	1F 旧情報ライブラリー																						撤去																						新設																																																																																																																																			
宿泊館	1F ブラザホール																						花壇・外壁																																																																																																														天井改修																																											

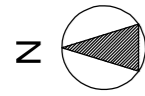

工事ステップ 1

凡例

- 工事エリア
- 使用可能エリア
- 使用可能昇降設備
- 使用可能便所
- 利用者動線
- 施設職員・関係者動線
- 工事動線
- 一時的な工事動線
(日時限定)

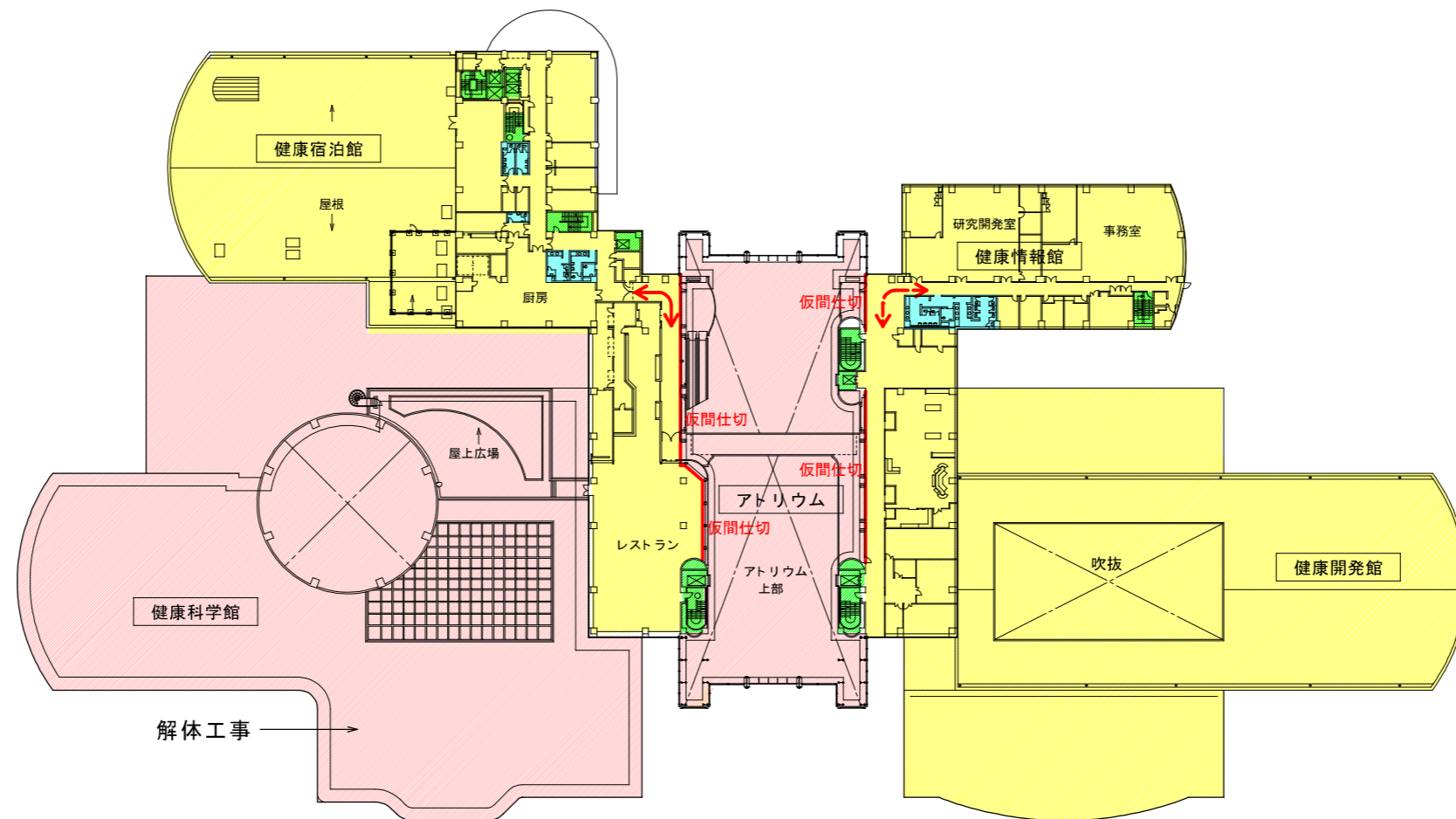

工事フロー

設備関係	1																						2										3																																
	1	2	3	4	5	6	7	8	9	10	11	12	13	14	15	16	17	18	19	20	21	22	1	2	3	4	5	6	7	8	9	10	11	12	13	14	15	16	17	18	19	20	21	22	1	2	3	4	5	6	7	8	9	10	11	12	13	14	15	16	17	18	19	20	21
設備関係	撤去・切り回し																						科学館		アトリウム		プール																																						
アトリウム																							アトリウム床撤去		防水改修		壁解体		外壁新設		屋根解体		仕上工事		クレンジング																														
科学館	科学館・落水庭																						準備仮囲		撤去		杭撤去		外壁新設		内装改修																																		
開発館	プール																						準備		耐震壁		撤去		外壁新設																																				
																							B1F アスチルルーム・フィットネスルーム		天井改修																																								
																							B1F レクリエーションジム		天井改修																																								
																							3F 旧クッキングルーム		旧リラクゼーションルーム		出入口・内装改修		解体・内装改修																																				
情報館	1F 旧情報ライブラリー																						撤去		新設																																								
宿泊館	1F ブラザホール																						花壇・外壁		天井改修																																								

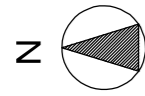

工事ステップ 1

凡例

- 工事エリア
- 使用可能エリア
- 使用可能昇降設備
- 使用可能便所
- 利用者動線
- 施設職員・関係者動線
- 工事動線
- 一時的な工事動線 (日時限定)

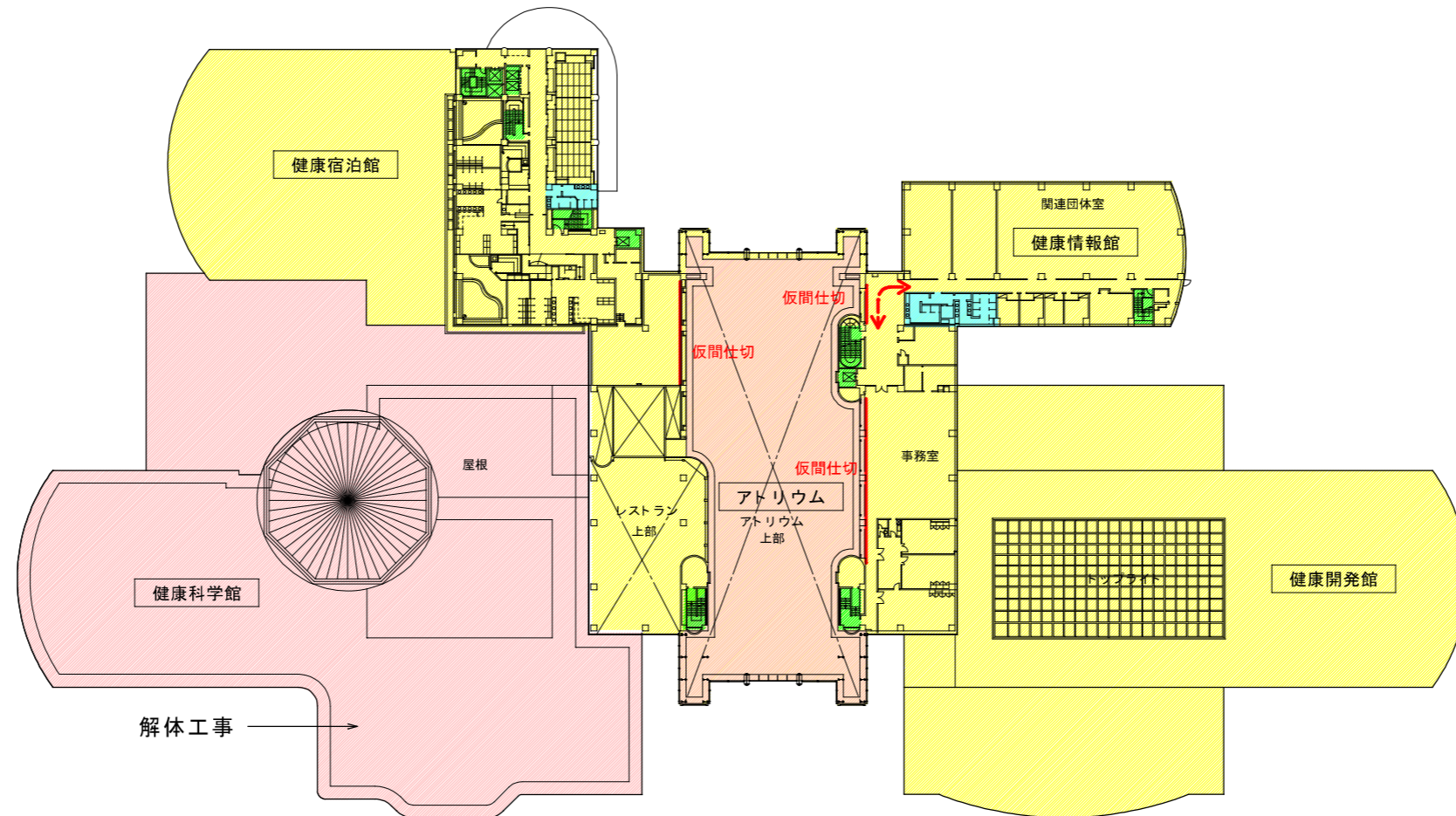

工事フロー

設備関係	1																						2										3																																
	1	2	3	4	5	6	7	8	9	10	11	12	13	14	15	16	17	18	19	20	21	22	1	2	3	4	5	6	7	8	9	10	11	12	13	14	15	16	17	18	19	20	21	22	1	2	3	4	5	6	7	8	9	10	11	12	13	14	15	16	17	18	19	20	21
設備関係	撤去・切り回し																						科学館		アトリウム		プール																																						
アトリウム																							アトリウム床撤去		防水改修		壁解体		外壁新設		屋根解体		仕上工事		クレーン																														
科学館	科学館・落水庭																						準備仮囲		撤去		杭撤去		外壁新設																																				
開発館	プール																						準備		耐震壁		撤去		外壁新設		内装改修																																		
	B1F アスチルルーム・フィットネスルーム																						天井改修																																										
	B1F レクリエーションジム																						天井改修																																										
	3F 旧キッチンルーム 旧リラクゼーションルーム																						出入口・内装改修		解体		内装改修																																						
情報館	1F 旧情報ライブラリー																						撤去		新設																																								
宿泊館	1F ブラザホール																						花壇・外壁		天井改修																																								

工事ステップ 2

凡例

- 工事エリア
- 使用可能エリア
- 使用可能昇降設備
- 使用可能便所
- 利用者動線
- 施設職員・関係者動線
- 工事動線
- 一時的な工事動線 (日時限定)
- SS スチールシャッター

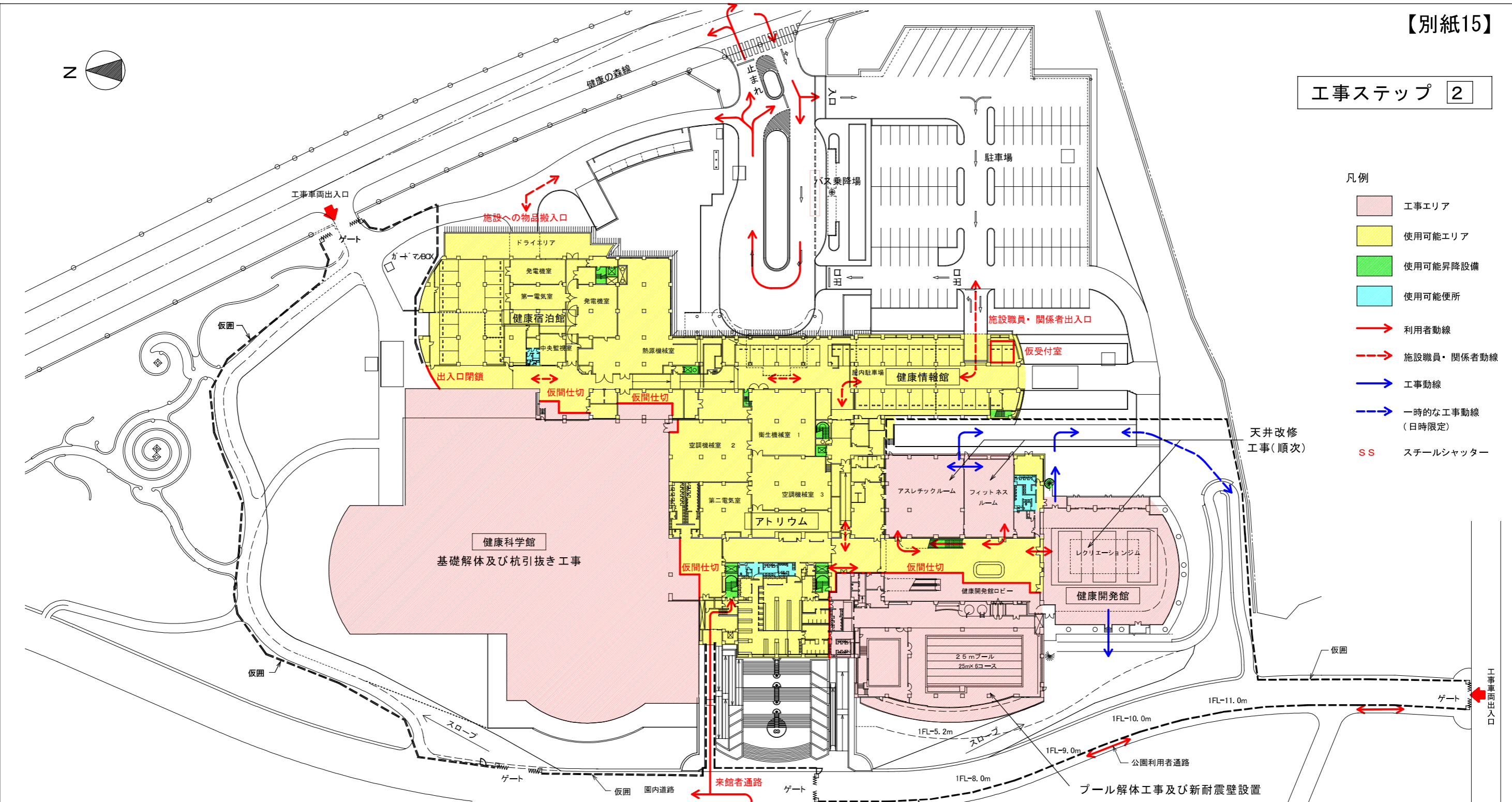

工事フロー

設備関係	工事ステップ 2																					
	1	2	3	4	5	6	7	8	9	10	11	12	13	14	15	16	17	18	19	20	21	22
設備関係	撤去・切り回し	科学館	アトリウム	プール																		
アトリウム			アトリウム床撤去		防水改修		壁解体		外壁新設		屋根解体		仕上工事		クレーン							
科学館	科学館・落水庭	準備仮囲い			撤去	杭撤去		外壁新設				内装改修										
開発館	プール			準備		耐震壁		撤去		外壁新設												
B1F アスレチックルーム・フィットネスルーム											天井改修											
B1F レクリエーションジム											天井改修											
3F 旧クッキングルーム 3F 旧リラクゼーションルーム											出入口・内装改修		解体		内装改修							
情報館	1F 旧情報ライブラリー	撤去		新設																		
宿泊館	1F プラザホール	花壇・外壁																				

工事ステップ 2

凡例

- 工事エリア
- 使用可能エリア
- 使用可能昇降設備
- 使用可能便所
- 利用者動線
- - - 施設職員・関係者動線
- 工事動線
- - - 一時的な工事動線 (日時限定)
- SS スチールシャッター

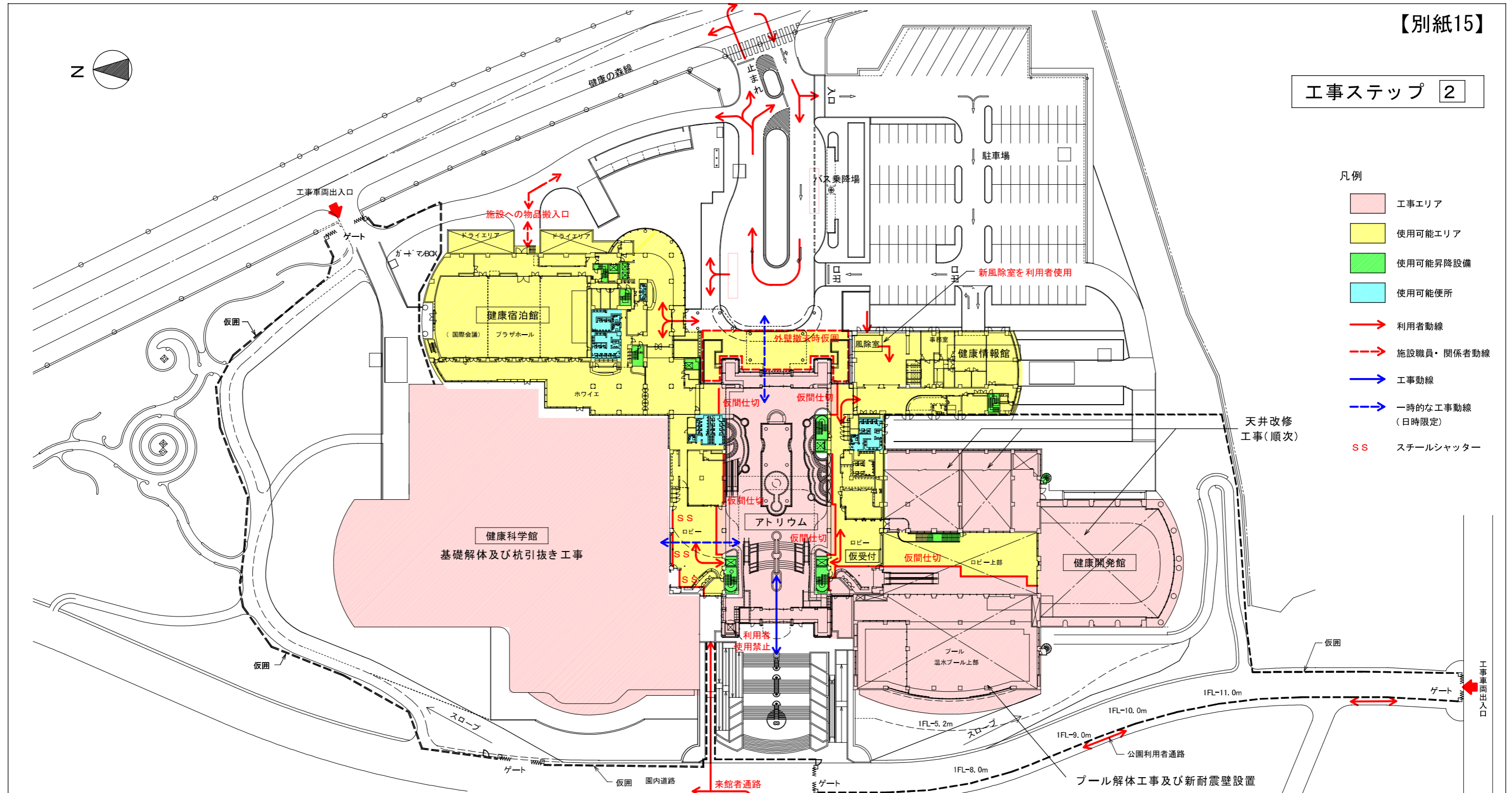

工事フロー

設備関係	1																						2																						3																																																																																																																																			
	1	2	3	4	5	6	7	8	9	10	11	12	13	14	15	16	17	18	19	20	21	22	1	2	3	4	5	6	7	8	9	10	11	12	13	14	15	16	17	18	19	20	21	22	1	2	3	4	5	6	7	8	9	10	11	12	13	14	15	16	17	18	19	20	21	22																																																																																																														
設備関係	撤去・切り回し																						科学館																						アトリウム																						プール																																																																																																													
アトリウム																							アトリウム床撤去																						防水改修																						壁解体																						外壁新設																						屋根解体																						仕上工事																						クレーン																					
科学館	科学館・落水庭																						準備仮囲																						撤去																						杭撤去																						外壁新設																																												内装改修																																											
開発館	プール																																												準備																						耐震壁																						撤去																						外壁新設																																																																	
	B1F アスナックルーム・フィットネスルーム																																												天井改修																																																																																																																																			
	B1F レクリエーションジム																																												天井改修																																																																																																																																			
	3F 旧クッキングルーム																																																																																								解体																						内装改修																																																																	
	3F 旧リラクゼーションルーム																																												出入口・内装改修																																																																																																																																			
情報館	1F 旧情報ライブラリー																						撤去																						新設																																																																																																																																			
宿泊館	1F プラザホール																						花壇・外壁																																																																		天井改修																																																																																							

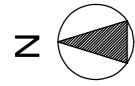

工事ステップ 2

凡例

- 工事エリア
- 使用可能エリア
- 使用可能昇降設備
- 使用可能便所
- 利用者動線
- 施設職員・関係者動線
- 工事動線
- 一時的な工事動線 (日時限定)

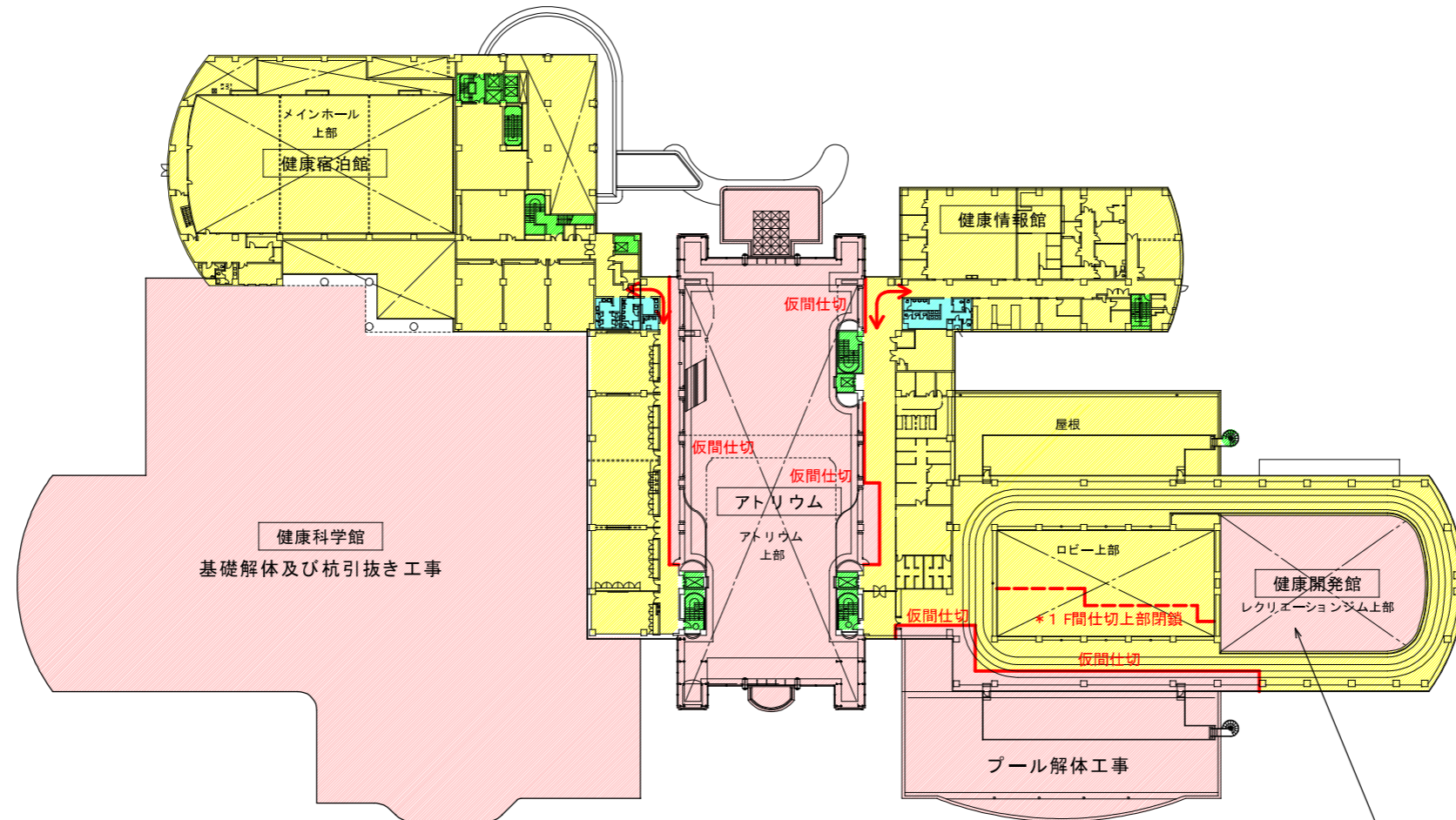

天井改修工事(順次)

工事フロー

設備関係	工事ステップ																												
	1							2										3											
	1	2	3	4	5	6	7	8	9	10	11	12	13	14	15	16	17	18	19	20	21	22							
設備関係	撤去・切り回し																												
科学館	科学館		アトリウム		プール																								
アトリウム	アトリウム床撤去																												
科学館	科学館・落水庭																												
開発館	プール																												
	B1F アスチルルーム・フィットネスルーム																												
	B1F レクリエーションジム																												
	3F 旧クッキングルーム 旧リラクゼーションルーム																												
情報館	1F 旧情報ライブラリー																												
宿泊館	1F ブラザホール																												



工事ステップ 2

凡例

- 工事エリア
- 使用可能エリア
- 使用可能昇降設備
- 使用可能便所
- 利用者動線
- 施設職員・関係者動線
- 工事動線
- 一時的な工事動線 (日時限定)

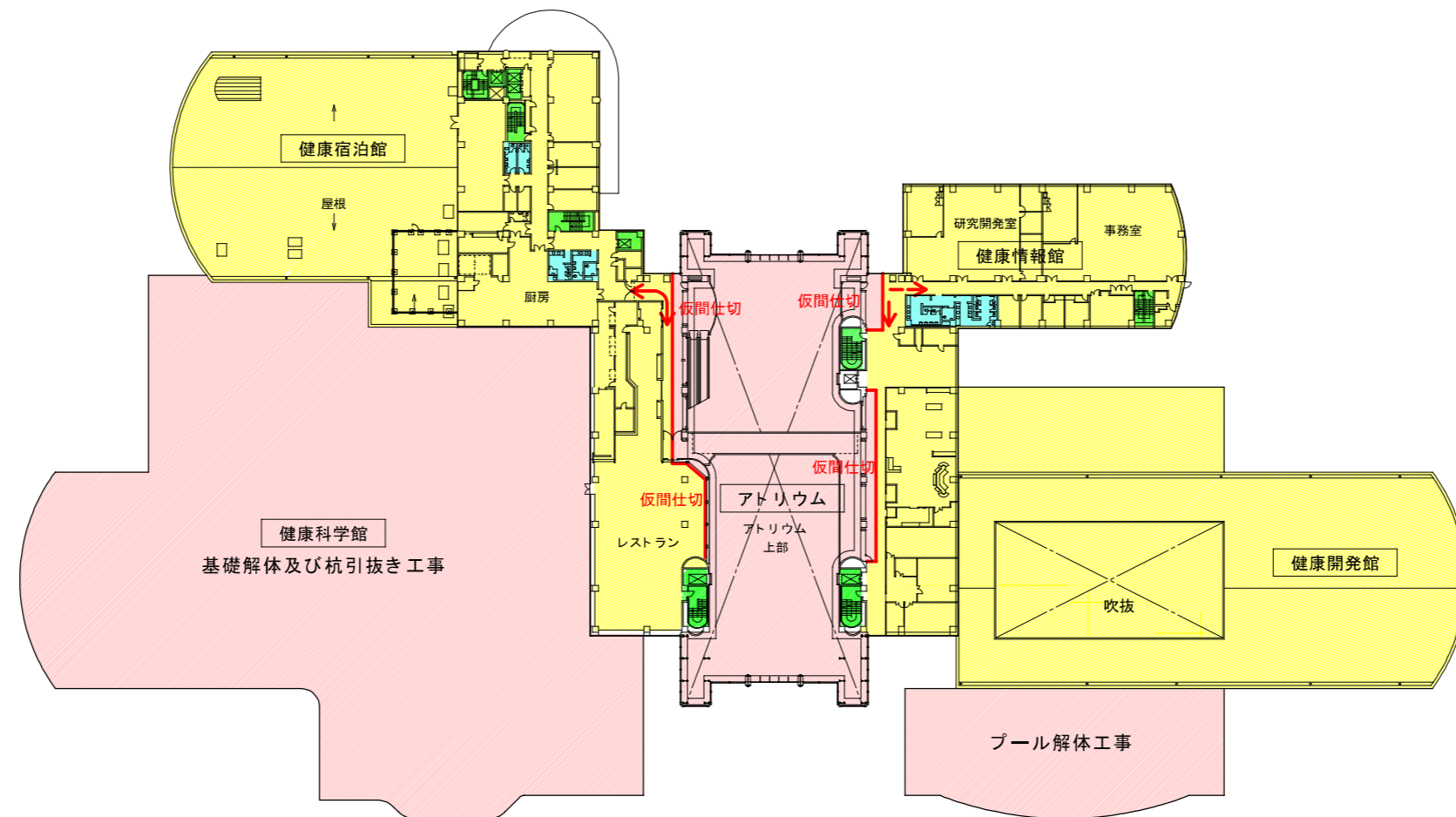

工事フロー

	1																						2										3																									
	1	2	3	4	5	6	7	8	9	10	11	12	13	14	15	16	17	18	19	20	21	22	1	2	3	4	5	6	7	8	9	10	11	12	13	14	15	16	17	18	19	20	21	22														
設備関係	撤去・切り回し																						科学館		アトリウム		プール																															
アトリウム																							アトリウム床撤去		防水改修		壁解体		外壁新設		屋根解体		仕上工事		クレーン																							
科学館	科学館・落水庭																						準備仮囲		撤去		杭撤去		外壁新設		内装改修																											
開発館	プール																						準備		耐震壁		撤去		外壁新設																													
																							B1F アスチルルーム・フィットネスルーム		天井改修																																	
																							B1F レクリエーションジム		天井改修																																	
																							3F 旧キッチンルーム		出入口・内装改修		解体		内装改修																													
																							3F 旧リラクゼーションルーム		出入口・内装改修		解体		内装改修																													
情報館	1F 旧情報ライブラリー																						撤去		新設																																	
宿泊館	1F ブラザホール																						花壇・外壁		天井改修																																	

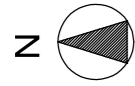

工事ステップ 2

凡例

- 工事エリア
- 使用可能エリア
- 使用可能昇降設備
- 使用可能便所
- 利用者動線
- 施設職員・関係者動線
- 工事動線
- 一時的な工事動線
(日時限定)

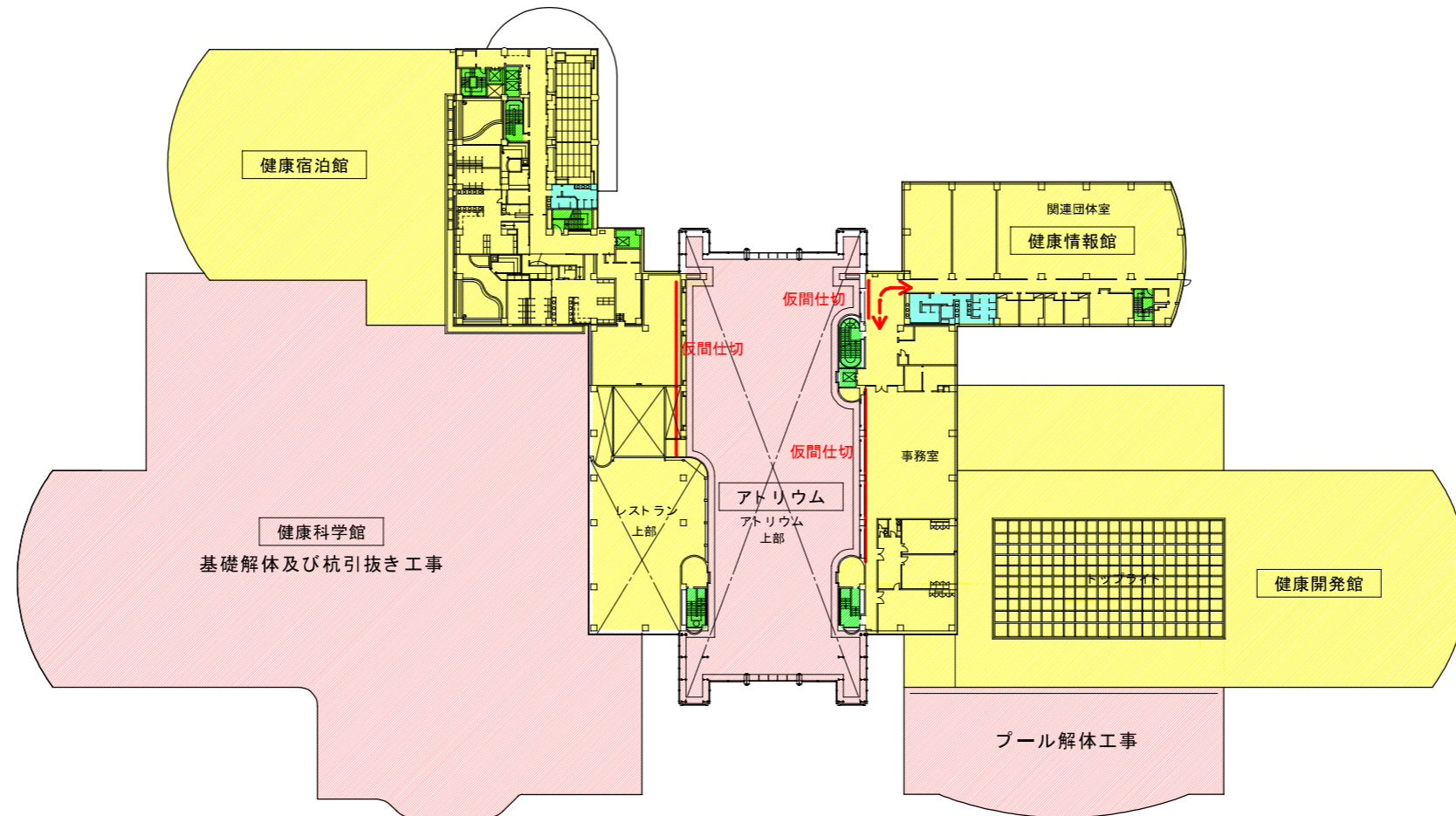

工事フロー

	1							2							3															
	1	2	3	4	5	6	7	8	9	10	11	12	13	14	15	16	17	18	19	20	21	22								
設備関係	撤去・切り回し																													
アトリウム	科学館		アトリウム		プール																									
アトリウム	アトリウム床撤去																													
アトリウム	防水改修																													
アトリウム	壁解体																													
アトリウム	外壁新設																													
アトリウム	屋根解体																													
アトリウム	仕上工事																													
アトリウム	クレンジング																													
科学館	科学館・落水庭																													
科学館	準備仮囲		撤去		杭撤去		外壁新設																							
開発館	プール																													
開発館	準備																													
開発館	耐震壁																													
開発館	撤去																													
開発館	外壁新設																													
開発館	内装改修																													
開発館	B1F アスチルルーム・フィットネスルーム																													
開発館	天井改修																													
開発館	B1F レクリエーションジム																													
開発館	天井改修																													
開発館	3F 旧クッキングルーム																													
開発館	旧リラクゼーションルーム																													
開発館	出入口・内装改修																													
情報館	1F 旧情報ライブラリー																													
情報館	撤去		新設																											
情報館	花壇・外壁																													
宿泊館	1F ブラザホール																													
宿泊館	天井改修																													

工事ステップ 3

凡例

- 工事エリア
- 使用可能エリア
- 使用可能昇降設備
- 使用可能便所
- 利用者動線
- - - 施設職員・関係者動線
- 工事動線
- - - 一時的な工事動線 (日時限定)
- SS スチールシャッター

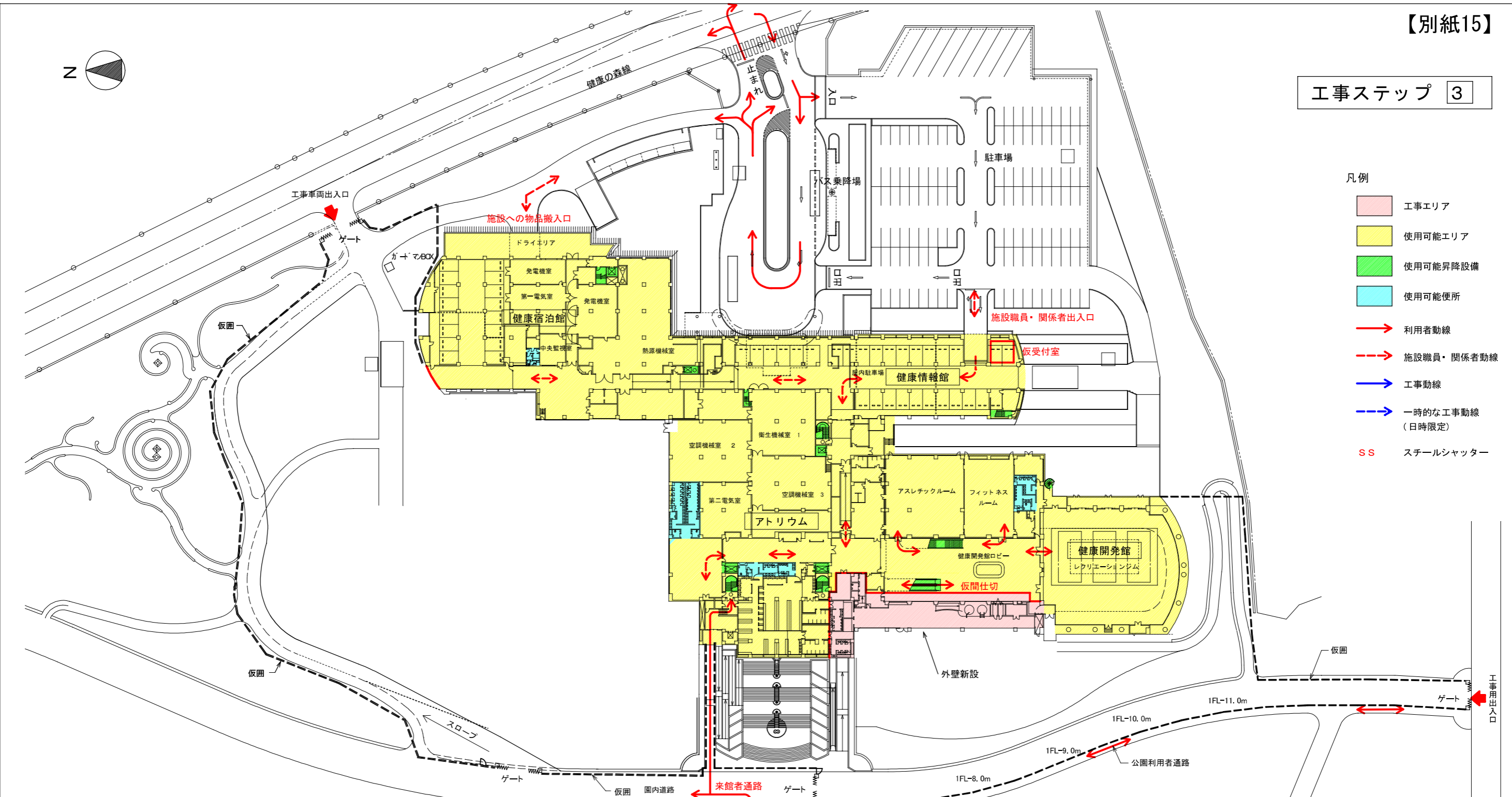

工事フロー

設備関係	1											2											3										
	1	2	3	4	5	6	7	8	9	10	11	12	13	14	15	16	17	18	19	20	21	22	23	24	25	26	27	28	29	30	31	32	
設備関係	撤去・切り回し																																
科学館	科学館		アトリウム		プール																												
アトリウム	アトリウム床撤去 防水改修 壁解体 外壁新設 屋根解体 仕上工事 クリーン																																
科学館	科学館・落水庭		準備仮囲		撤去		杭撤去		外壁新設																								
開発館	プール		準備		耐震壁		撤去		外壁新設																								
B1F アスレチックルーム・フィットネスルーム	天井改修																																
B1F レクリエーションジム	天井改修																																
3F 旧クッキングルーム 旧リラクゼーションルーム	出入口・内装改修																																
情報館	1F 旧情報ライブラリー		撤去		新設																												
宿泊館	1F ブラザホール		花壇・外壁																														

工事ステップ 3

凡例

- 工事エリア
- 使用可能エリア
- 使用可能昇降設備
- 使用可能便所
- 利用者動線
- 施設職員・関係者動線
- 工事動線
- 一時的な工事動線
(日時限定)
- SS スチールシャッター

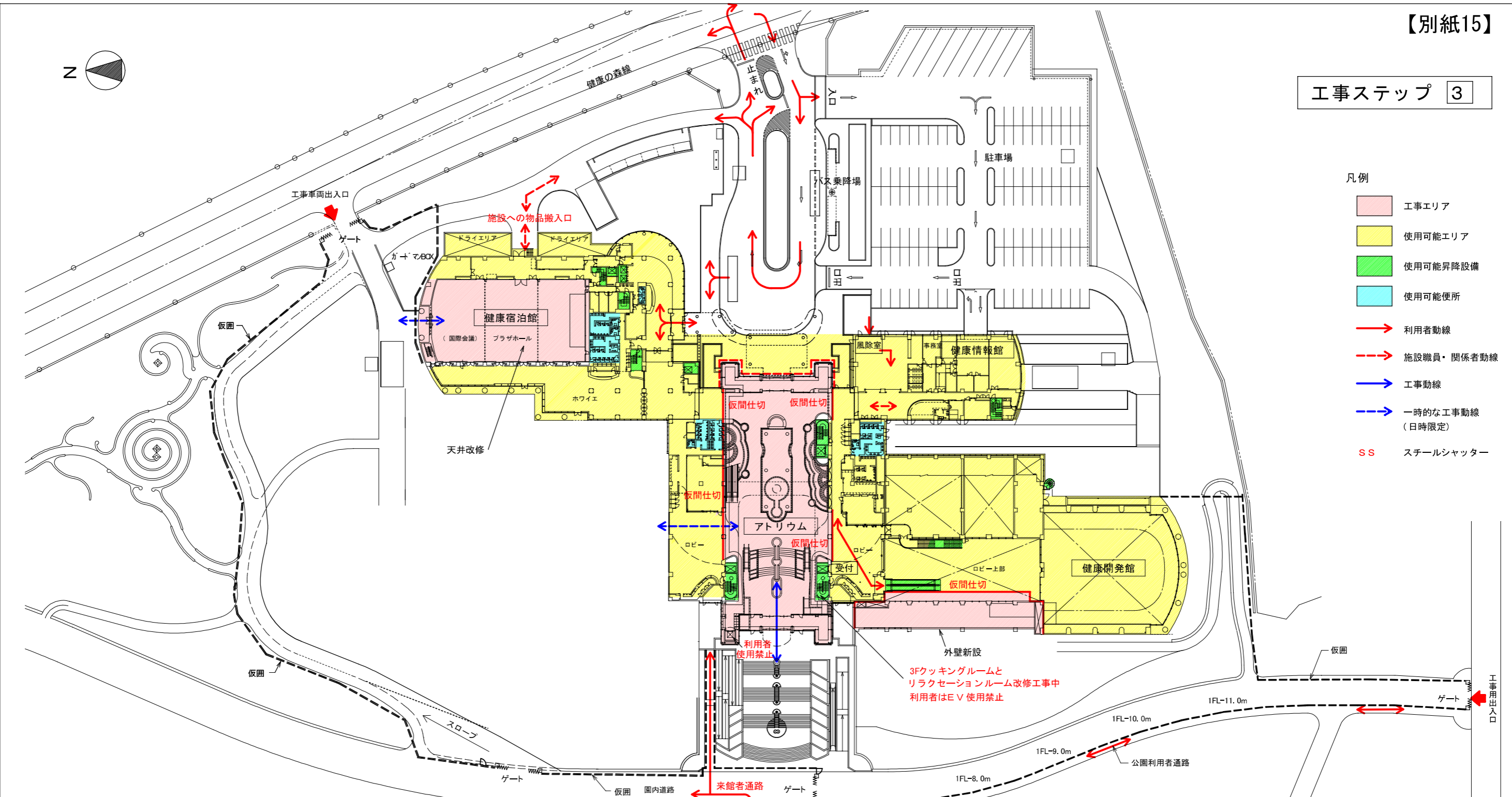

工事フロー

	3																					
	1	2	3	4	5	6	7	8	9	10	11	12	13	14	15	16	17	18	19	20	21	22
設備関係	撤去・切り回し																					
科学館	科学館	アトリウム	プール																			
アトリウム	アトリウム床撤去 防水改修 壁解体 外壁新設 屋根解体 仕上工事 クリーニング																					
科学館	科学館・落水庭 準備仮囲 撤去 杭撤去 外壁新設 内装改修																					
開発館	プール 準備 耐震壁 撤去 外壁新設																					
B1F 7スチクルーム・フィットネスルーム	天井改修																					
B1F レクリエーションジム	天井改修																					
3F 旧クッキングルーム 旧リラクゼーションルーム	出入口・内装改修 解体 内装改修																					
情報館	1F 旧情報ライブラリー 撤去 新設																					
宿泊館	1F プラザホール 花壇・外壁 天井改修																					

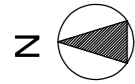

工事ステップ 3

凡例

- 工事エリア
- 使用可能エリア
- 使用可能昇降設備
- 使用可能便所
- 利用者動線
- 施設職員・関係者動線
- 工事動線
- 一時的な工事動線 (日時限定)

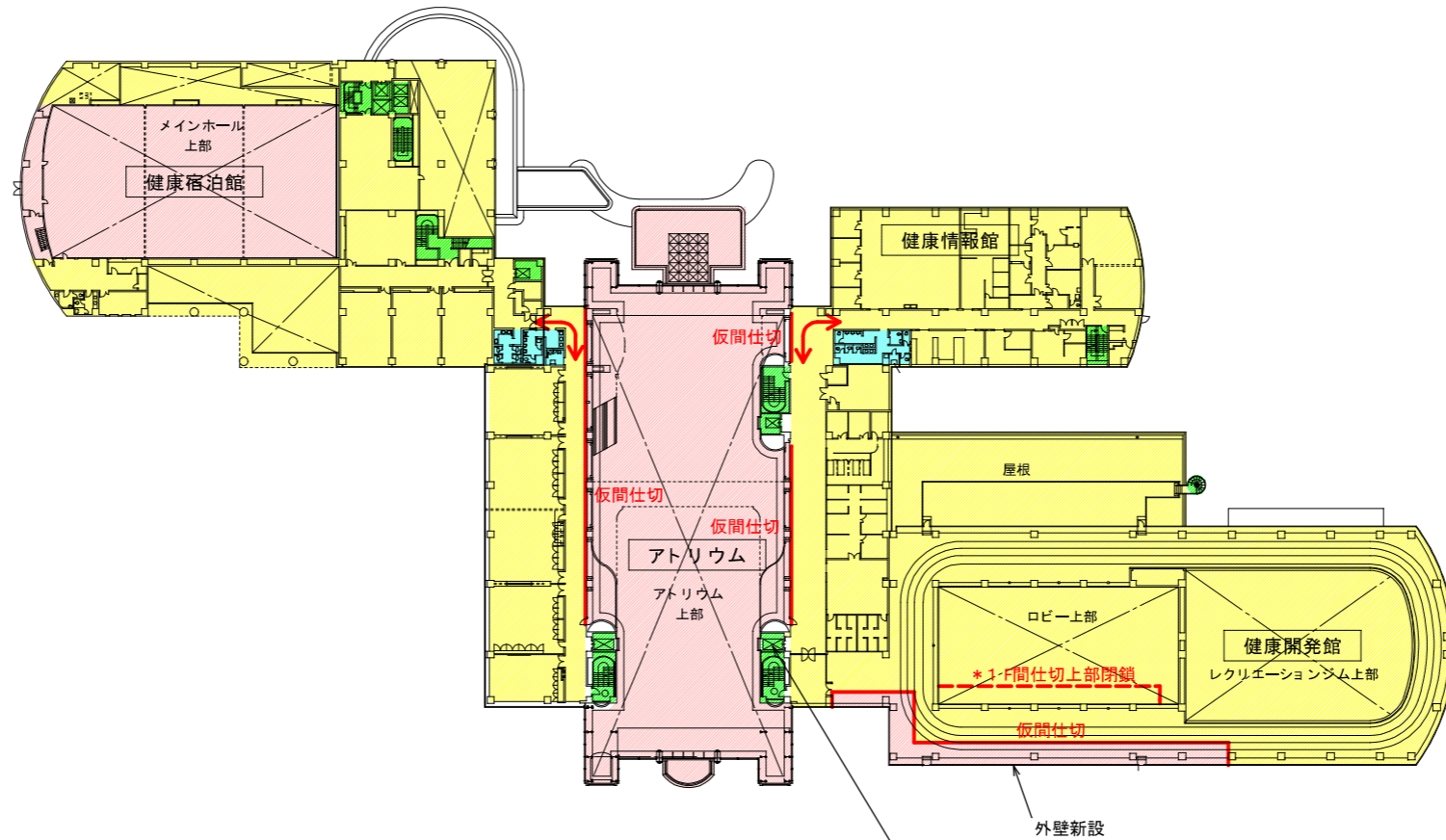

3Fキッチンルームと
リラクゼーションルーム改修工事中
利用者はE.V.使用禁止

工事フロー

設備関係	工事ステップ																					
	1	2	3	4	5	6	7	8	9	10	11	12	13	14	15	16	17	18	19	20	21	22
設備関係	撤去・切り回し																					
科学館	科学館	アトリウム	プール																			
アトリウム	アトリウム床撤去 防水改修 壁解体 外壁新設 屋根解体 仕上工事 クリーニング																					
科学館	科学館・落水庭	準備仮囲	撤去	杭撤去	外壁新設																	内装改修
開発館	プール																					
	準備 耐震壁 撤去 外壁新設																					
	B1F アスナックルーム・フィットネスルーム																					
	天井改修																					
	B1F レクリエーションジム																					
	天井改修																					
	3F 旧キッチンルーム 旧リラクゼーションルーム																					
	出入口・内装改修																					
情報館	1F 旧情報ライブラリー																					
	撤去 新設																					
宿泊館	1F ブラザホール																					
	花壇・外壁																					
	天井改修																					

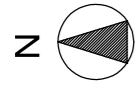

工事ステップ 3

凡例

- 工事エリア
- 使用可能エリア
- 使用可能昇降設備
- 使用可能便所
- 利用者動線
- 施設職員・関係者動線
- 工事動線
- 一時的な工事動線 (日時限定)

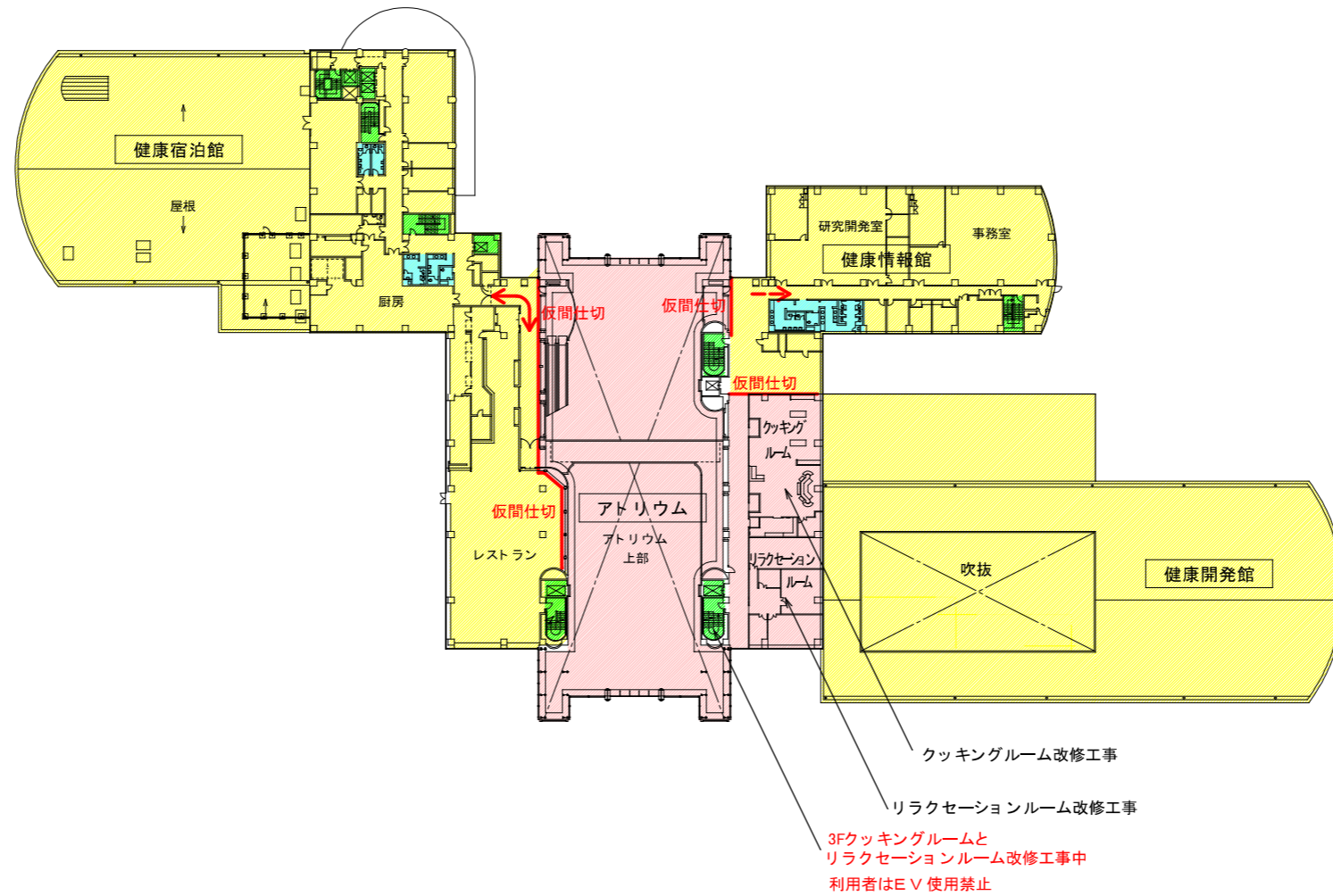

工事フロー

設備関係	1																						2						3																							
	1	2	3	4	5	6	7	8	9	10	11	12	13	14	15	16	17	18	19	20	21	22																														
設備関係	撤去・切り回し																						科学館		アトリウム		プール																									
アトリウム																							アトリウム床撤去		防水改修		壁解体		外壁新設		屋根解体		仕上工事		クレンジ																	
科学館	科学館・落水庭																						準備仮囲		撤去		杭撤去		外壁新設																							
開発館	プール																						準備		耐震壁		撤去		外壁新設		内装改修																					
	B1F アスチクルーム・フィットネスルーム																						天井改修																													
	B1F レクリエーションジム																						天井改修																													
	3F 旧クッキングルーム 旧リラクゼーションルーム																						出入口・内装改修		解体		内装改修																									
情報館	1F 旧情報ライブラリー																						撤去		新設																											
宿泊館	1F ブラザホール																						花壇・外壁		天井改修																											

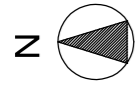

工事ステップ 3

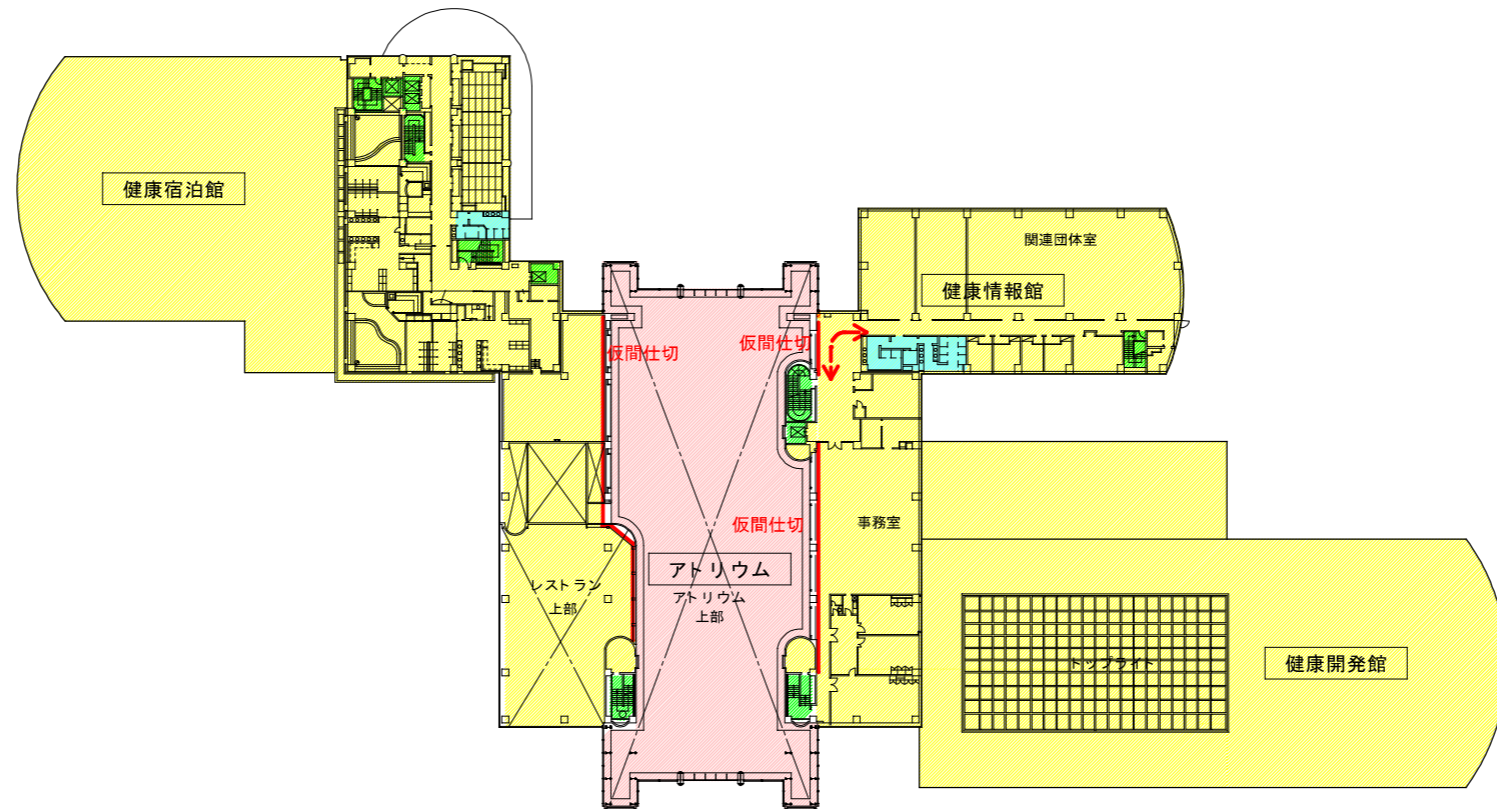

凡例

- 工事エリア
- 使用可能エリア
- 使用可能昇降設備
- 使用可能便所
- 利用者動線
- 施設職員・関係者動線
- 工事動線
- 一時的な工事動線
(日時限定)

工事フロー

	1																						2										3																																
	1	2	3	4	5	6	7	8	9	10	11	12	13	14	15	16	17	18	19	20	21	22	1	2	3	4	5	6	7	8	9	10	11	12	13	14	15	16	17	18	19	20	21	22	1	2	3	4	5	6	7	8	9	10	11	12	13	14	15	16	17	18	19	20	21
設備関係	撤去・切り回し																						科学館		アトリウム		プール																																						
アトリウム																							アトリウム床撤去		防水改修		壁解体		外壁新設		屋根解体		仕上工事		クレーン																														
科学館	科学館・落水庭																						準備仮囲		撤去		杭撤去		外壁新設																																				
開発館	プール																						準備		耐震壁		撤去		外壁新設		内装改修																																		
																							B1F アスチルルーム・フィットネスルーム		天井改修																																								
																							B1F レクリエーションジム		天井改修																																								
																							3F 旧クッキングルーム 旧リラクゼーションルーム		出入口・内装改修		解体		内装改修																																				
情報館	1F 旧情報ライブラリー																						撤去		新設																																								
宿泊館	1F ブラザホール																						花壇・外壁		天井改修																																								

工事ステップ 3

屋根解体工事

凡例

- 工事エリア
- 使用可能エリア
- 使用可能昇降設備
- 使用可能便所
- 利用者動線
- 施設職員・関係者動線
- 工事動線
- 一時的な工事動線 (日時限定)

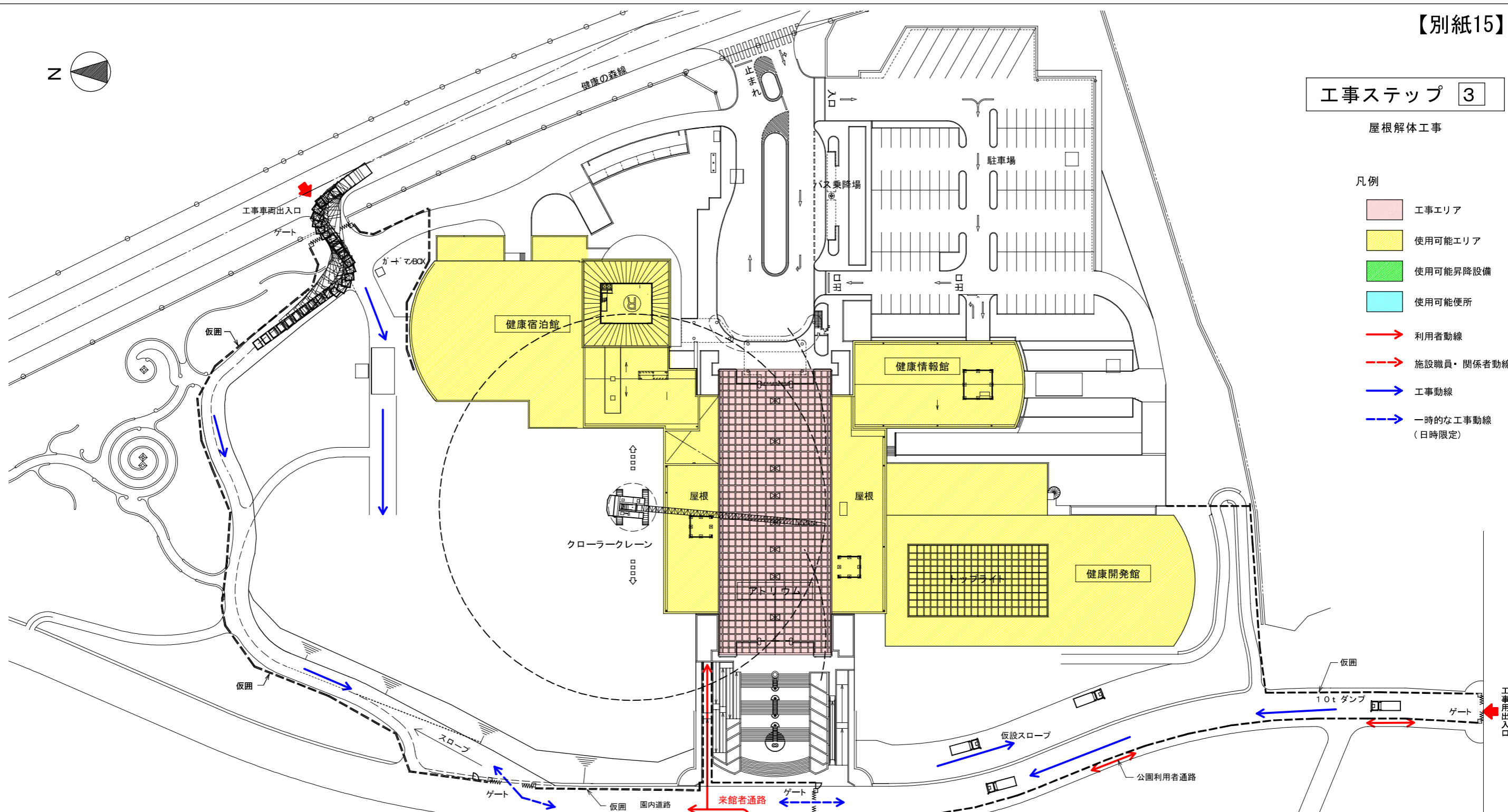

工事フロー	1 2 3																					
	1	2	3	4	5	6	7	8	9	10	11	12	13	14	15	16	17	18	19	20	21	22
設備関係	撤去・切り回し																					
科学館	科学館	アトリウム				プール																
アトリウム																						
科学館	科学館・落水庭																					
開発館	プール																					
B1F	7スチクルーム・フィットネスルーム																					
B1F	レクリエーションジム																					
3F	旧クッキングルーム 旧リラクゼーションルーム																					
情報館	1F 旧情報ライブラリー																					
宿泊館	1F プラザホール																					